



# Specification

## HR310

SSC		Customer
Drawn	Approval	Approval

# Contents

1. Features
2. Absolute Maximum Ratings
3. Electric-Optical Characteristics
4. Reliability Tests
5. Characteristic Diagrams
6. Color & Binning
7. Outline Dimensions
8. Packing
9. Soldering
10. Precaution for use

# HR310

## Description

This revolutionary package design allows the lighting designer to reduce the number of LEDs required and provide a more uniform and unique illuminated appearance than with other LED solutions.

This package LEDs are designed for high current operation and high flux output application. But the package's design features better thermal management characteristics than other LED solutions. Because of these advantages, this product have many applications. Such as automotive tail, stop and turn signal lamps, and electronic signs etc.



# HR310

## Features

- High flux output and high luminance
- Designed for high current operation
- Uniform color
- Low profile and low thermal resistance
- Packaged in tubes for use with automatic insertion equipment

## Applications

- Automotive exterior lighting
- Electronic signs and signals
- Channel letter / lighting
- Decorative lighting
- Specialty Lighting

## 2. Absolute Maximum Ratings ( $T_a = 25^{\circ}\text{C}$ )

Item	Symbol	Value	Unit
DC Forward Current	$I_F$	70	mA
Forward Peak Pulse Current	$I_{FP}^{[1]}$	100	mA
Reverse Voltage	$V_R$	5	V
Power Dissipation	$P_D$	224	mW
Operating Temperature	$T_{opr}$	-40 ~ 100	$^{\circ}\text{C}$
Storage Temperature	$T_{stg}$	-50 ~ 105	$^{\circ}\text{C}$
Solder Temperature	$T_S$	260 $^{\circ}\text{C}$ for 5second <sup>[2]</sup>	$^{\circ}\text{C}$

Notes :

[1]  $t \leq 0.1\text{ms}$ ,  $D = 1/10$

[2] No closer than 1.5mm from the base of the stopper.

## 3. Electro-Optical Characteristics ( $T_a = 25^{\circ}\text{C}$ , $I_F=70\text{mA}$ )

Item	Symbol	Value			Unit
		Min.	Typ.	Max.	
Luminous Flux <sup>[3]</sup>	$\Phi_V^{[4]}$	4.4	6.0	-	lm
Luminous Intensity	$I_V$	-	10000	-	mcd
Dominant Wavelength <sup>[5]</sup>	$\lambda_d$	615	625	630	nm
Forward Voltage <sup>[6]</sup>	$V_F$	-	2.6	3.0	V
View Angle	$2\theta_{1/2}$	40			deg.
Thermal Resistance	$R\theta_{J-P}$	120			$^{\circ}\text{C}/\text{W}$
Optical Efficiency	$\eta_{opt}$	-	33	-	lm/W
Reverse Current (at $V_R = 5\text{V}$ )	$I_R$	-	-	5	$\mu\text{A}$

Notes :

[3] SSC maintains a tolerance of  $\pm 10\%$  on flux and power measurements.

[4]  $\Phi_V$  is the total luminous flux output as measured with an integrated sphere.

[5] Dominant wavelength is derived from the CIE 1931 Chromaticity diagram.

A tolerance of  $\pm 0.5\text{nm}$  for dominant wavelength.

[6] A tolerance of  $\pm 0.05\text{V}$  on forward voltage measurements.

Rev. 00

December 2007

www.ZLED.com

## 4. Reliability Tests

Item	Condition	Note	Failures
Life Test	$T_a = RT, I_F = 70mA$	1000hrs	0/22
High Temperature Operating	$T_a = 100^{\circ}C, I_F = 20mA$	1000hrs	0/22
Low Temperature Operating	$T_a = -40^{\circ}C, I_F = 70mA$	1000hrs	0/22
Thermal Shock	$T_a = -50^{\circ}C$ (30min) ~ $105^{\circ}C$ (30min) (Transfer time : 5sec, 1Cycle = 1hr)	100 cycles	0/40
Resistance to soldering Heat	$T_s = 255 \pm 5^{\circ}C, t = 4 \pm 1sec$	1 time	0/22
ESD (Human Body Model)	1kV, 1.5k $\Omega$ ; 100pF	1 time	0/22
High Temperature Storage	$T_a = 105^{\circ}C$	1000hrs	0/22
Low Temperature Storage	$T_a = -50^{\circ}C$	1000hrs	0/22
Temperature Humidity Storage	$T_a = 85^{\circ}C, RH = 85\%$	1000hrs	0/22
Temperature Humidity Operating	$T_a = 85^{\circ}C, RH = 85\%, I_F = 40mA$	500hrs	0/22

### < Judging Criteria For Reliability Tests >

$V_F$	USL <sup>[1]</sup> X 1.2
$I_R$	USL X 2.0
$\Phi_V$	LSL <sup>[2]</sup> X 0.7

Notes :

[1] USL : Upper Standard Level

[2] LSL : Lower Standard Level.

## 5. Characteristic Diagrams

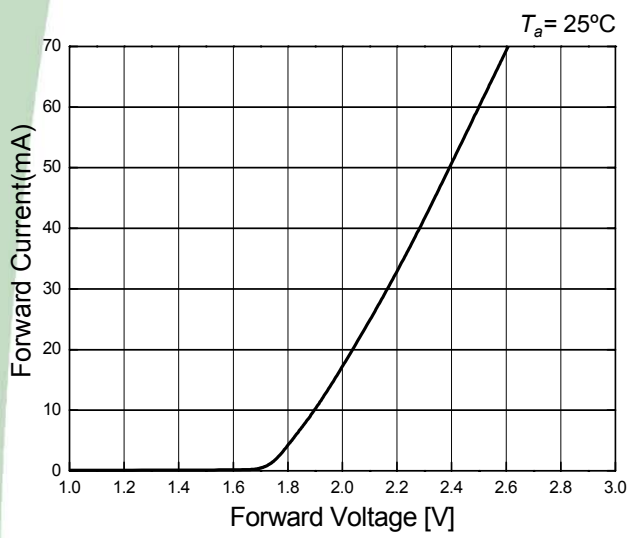

Forward Voltage vs. Forward Current

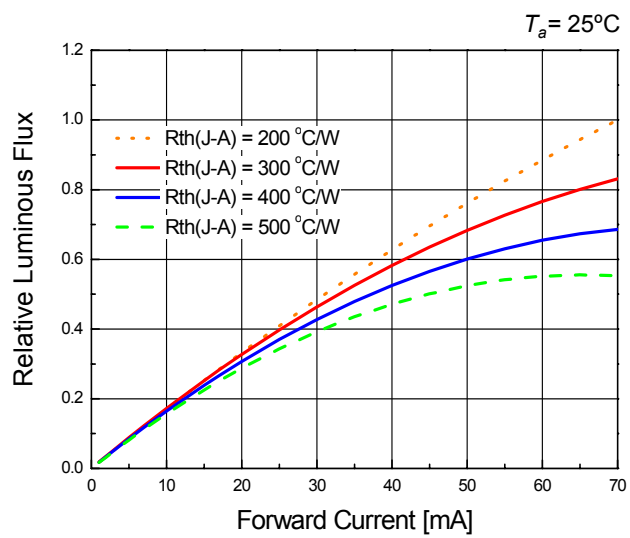

Forward Current vs. Relative Flux

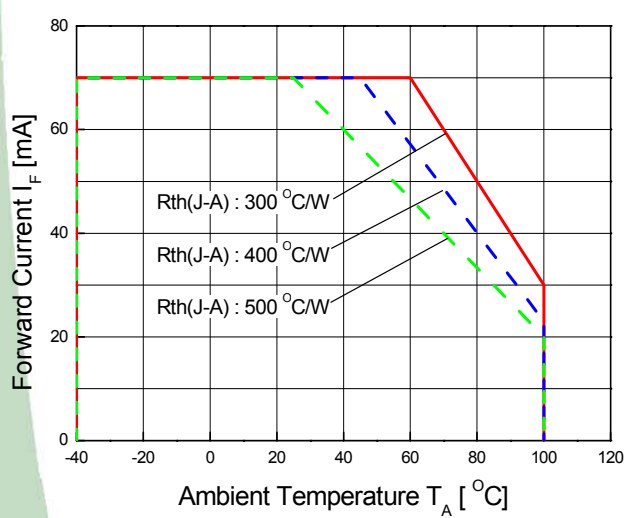

Ambient Temperature vs. Maximum Forward Current

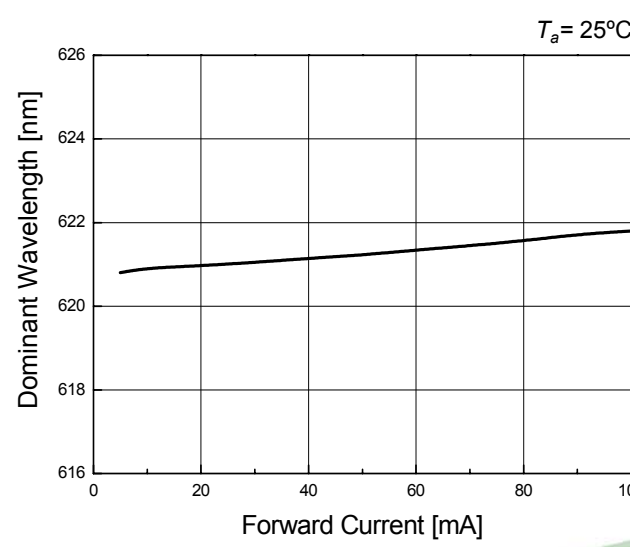

Forward Current vs. Dominant Wavelength

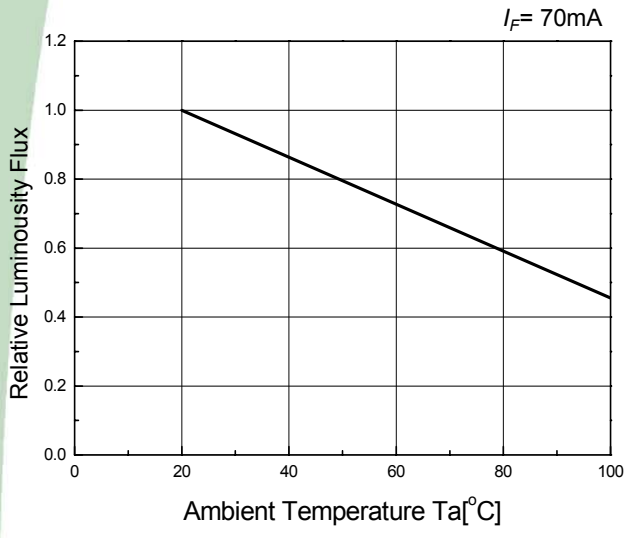

Ambient Temperature vs. Relative Flux

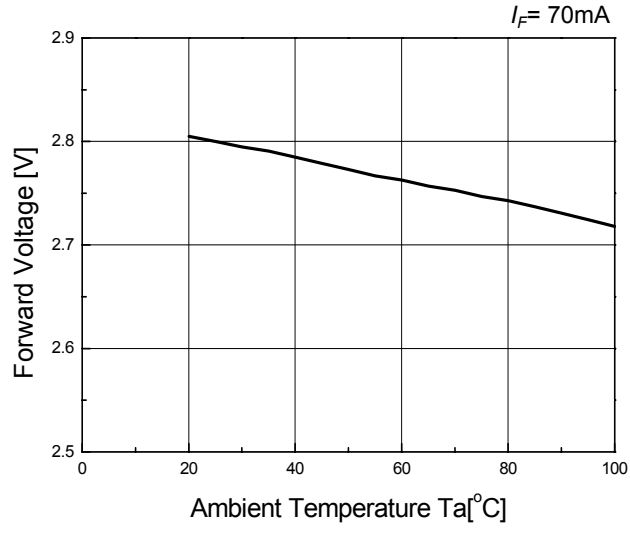

Ambient Temperature vs. Forward Voltage

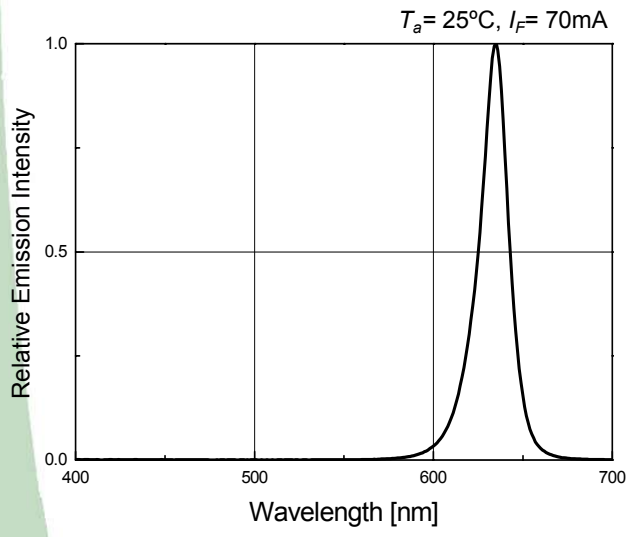

Spectrum

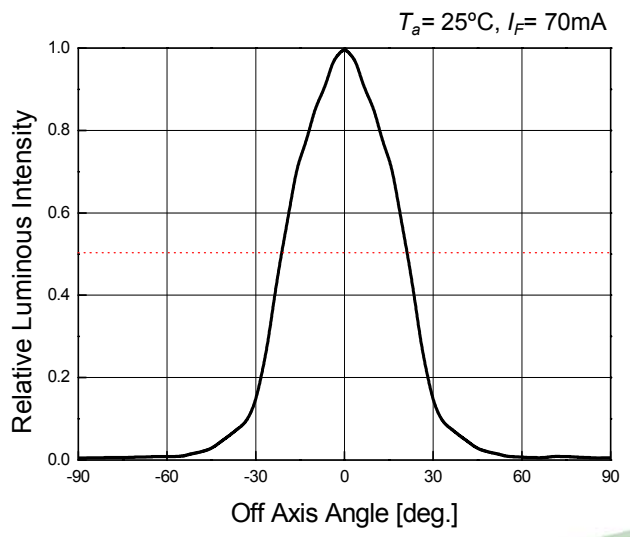

Directivity

## 6. Color & Binning

Bin Code		
Luminous Flux	Dominant Wavelength	Forward Voltage
J	1	3

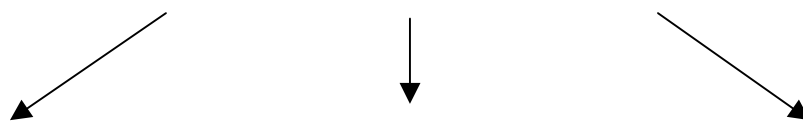

Luminous Flux (lm) @ $I_F = 70\text{mA}$		
Bin Code	Min.	Max.
A	0.5	0.7
B	0.7	1.0
C	1.0	1.4
D	1.4	2.0
E	2.0	2.6
F	2.6	3.4
G	3.4	4.4
H	4.4	5.8
J	5.8	7.6
K	7.6	10.0
L	10.0	13.0

Dominant Wavelength (nm) @ $I_F = 70\text{mA}$		
Bin Code	Min.	Max.
0	615	620
1	620	625
2	625	630

Forward Voltage (V) @ $I_F = 70\text{mA}$		
Bin Code	Min.	Max.
1	2.20	2.35
2	2.35	2.50
3	2.50	2.60
4	2.60	2.70
5	2.70	2.85
6	2.85	3.00

Available ranks



## 7. Outline Dimensions

Unit : mm

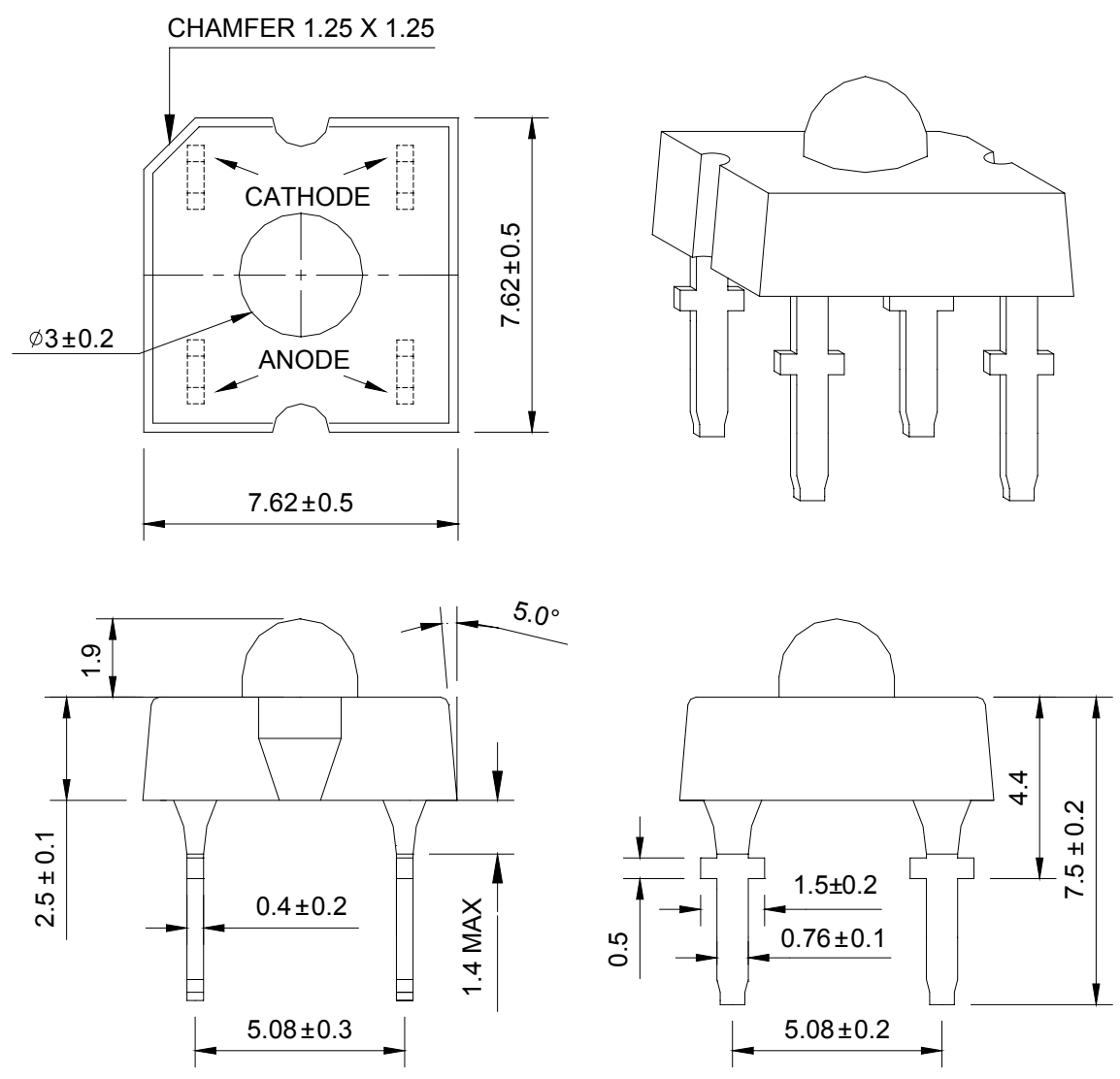

Notes : Protruded epoxy is 1.0mm maximum.

### 8. Packing

Unit : mm

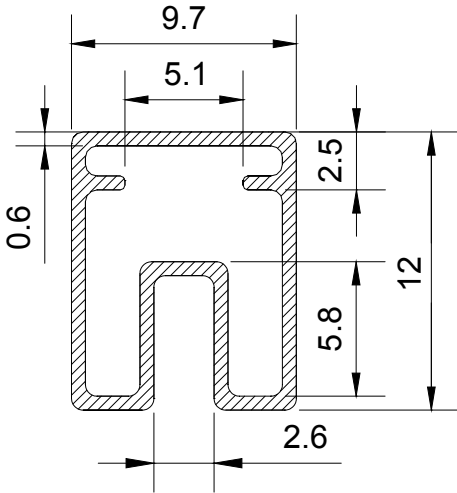

Cathode ○ → ● Anode

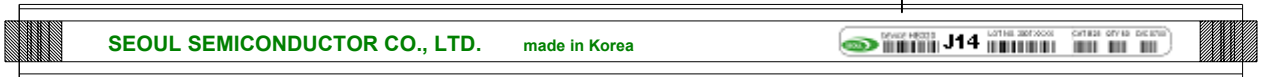

Top view

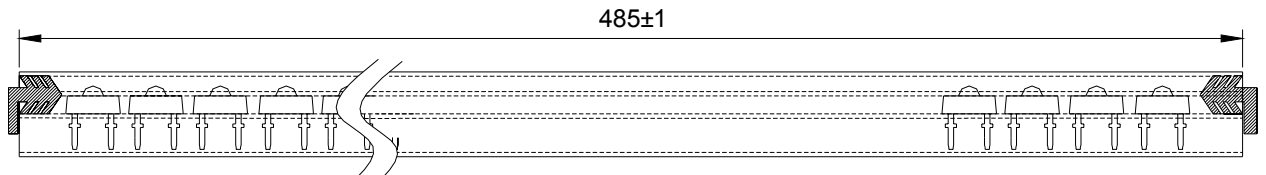

Side view

\* Plastic tube  
60pcs max/tube

Unit : mm

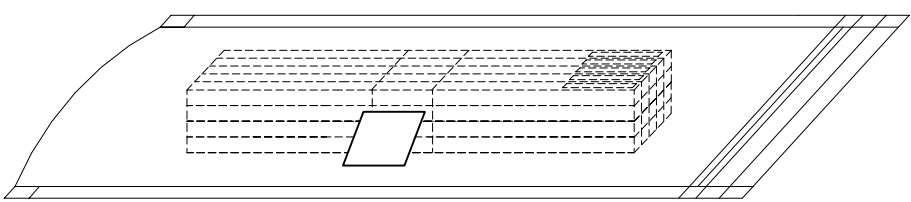

1200pcs max/pack  
(20tubes max/pack)

\* Aluminum Sealing pack (in silica gel)

**HXXXX**

RANK : XXXX

QTY : 1200pcs

LOT : 20XX.XX.XX



 SEOUL SEMICONDUCTOR CO., LTD

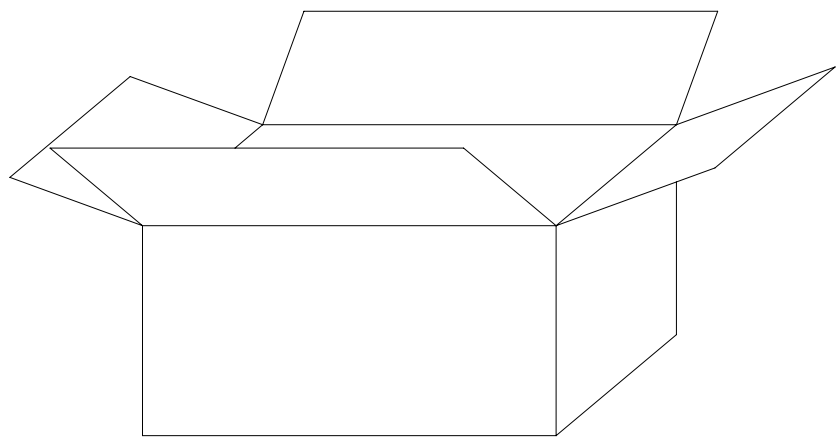

\* Cardboard box (500x220x280)  
(21600pcs max/box)  
(18packs max/box)

Rev. 00

December 2007

www.ZLED.com

## 9. Soldering Profile

### 1) Recommended Wave Soldering Conditions / Profile

- Preliminary heating to be at 85°C(120 °C max) for 20 seconds(60 seconds max).
- Soldering heat to be at 255 °C (260°C max) for 4 seconds (5 seconds max.)
- Soak time above 200 °C is 5 seconds

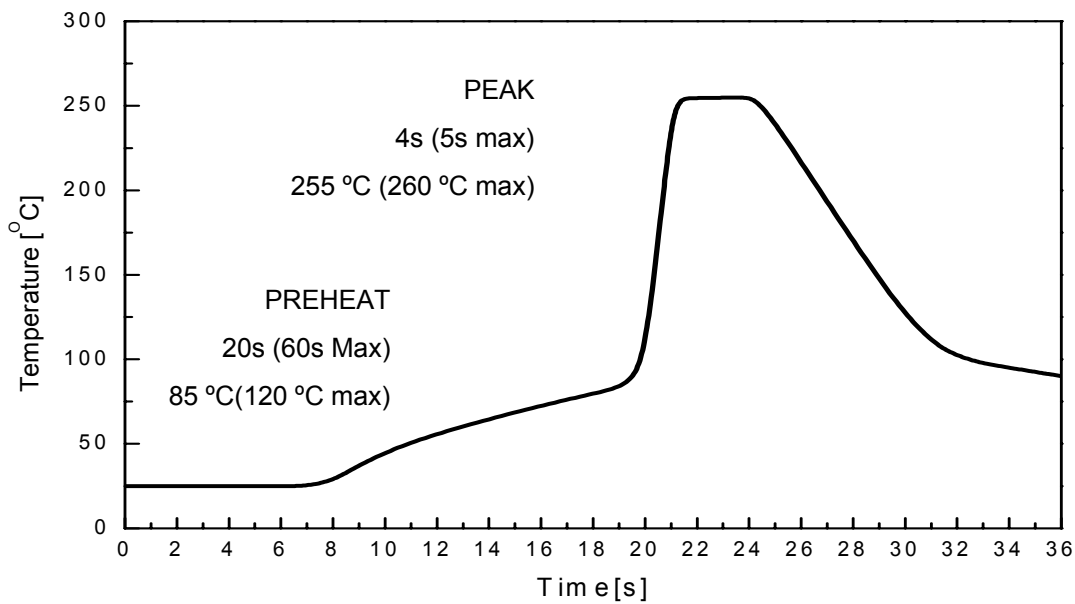

### 2) Hand Soldering conditions

- Not more than 3 seconds at max. 350°C, under Soldering iron.

### 3) Caution

- Lead frames are silver plated copper alloy. This substance has a low thermal coefficient (easily conducts heat)
- No closer than 1.5mm from the base of the stopper.
- The LEDs must not be repositioned after soldering.
- Do not apply any stress to the lead particularly when heat.

Note : In case the soldered products are reused in soldering process, we don't guarantee the products.

## 10. Precaution for Use

### 1) Storage

- Before opening the package

Avoid the absorption of moisture, we recommended to store High Flux LEDs in a dry box(or desiccator) with a desiccant . Otherwise, store them in the following environment:

Temperature : 5℃~30℃ Humidity : 50% max.

- After opening the package

a. Soldering should be done right after opening the package(within 24Hrs).

b. Keeping of a fraction

- Sealing

- Temperature : 5 ~ 40℃, Humidity : less than 30%

c. If the package has been opened more than 1week or the color of desiccant changes, Components should be dried for 10-12hr at 60±5℃

- Any mechanical force or any excess vibration shall not be accepted to apply during cooling process to normal temp. after soldering.
- Avoid quick cooling
- Leadframes are silver plated copper alloy. The silver plate surface may be affected by environments which contains corrosive substances. Please avoid conditions which may cause the LEDs to corrode, tarnish or discolor.

### 2) Static Electricity

- Static Electricity and surge voltage damage the LEDs. So it is recommended that a wrist band or an anti-electrostatic glove be used when handling the LEDs.

- All devices, equipment and machinery must be properly grounded.

It is recommended precautions be taken against surge voltage to the equipment that mounts the LEDs.

### 3) Heat Generation

- Thermal is one of the important parameter to design the end product. Please consider the heat generation of the LEDs.

- The operating current should be decided after considering the ambient maximum temperature of LEDs.

4) Others

- The color of the LEDs is changed a little by an operating current and thermal.
- Anti radioactive ray design is not considered for the products listed here in.
- Gallium arsenide is used in some of the products listed in this publication. These products are dangerous if they are burned or smashed in the process of disposal. It is also dangerous to drink the liquid or inhale the gas generated by such products when chemically disposed.
- This device should not be used in any type of fluid such as water, oil, organic solvent and etc. When washing is required, IPA(Isopropyl Alcohol) should be used.
- When the LEDs are illuminating, operating current should be decided after considering the junction temperature.

Cf.) Please refer *Ambient temperature vs. Forward Current* graph on page 5

- The appearance and specifications of the product may be modified for improvement without notice.

**SEOUL SEMICONDUCTOR CO., LTD.**

148-29, Kasan-Dong, Keumchun-Gu, Seoul, Korea

TEL : +82-2-3281-6269 FAX :+82-2-858-5537

Homepage : [www.seoulsemicon.com](http://www.seoulsemicon.com) [www.zled.com](http://www.zled.com)

E-Store : [www.zledstore.com](http://www.zledstore.com)

E-mail : [sscsale@seoulsemicon.com](mailto:sscsale@seoulsemicon.com)