



Specification

KWT728-S

SSC		CUSTOMER
Drawn	Approval	Approval

CONTENTS

1. Description
2. Absolute Maximum Ratings
3. Electric & Optical Characteristics
4. Optical characteristics
5. Reliability Test
6. Color & Binning
7. Bin Code Description
8. Outline Dimension
9. Packing
- 10 Soldering
11. Precaution for use
12. Handling of Silicone Resin LEDs

KWT728-S

1. Description

This surface-mount LED comes in PLCC standard package dimension. It has a substrate made up of a molded plastic reflector sitting on top of a bent lead frame. The die is attached within the reflector cavity and the cavity is encapsulated by epoxy or silicone.

The package design coupled with careful selection of component materials allow these products to perform with high reliability in a larger temperature range -40°C to 85°C.

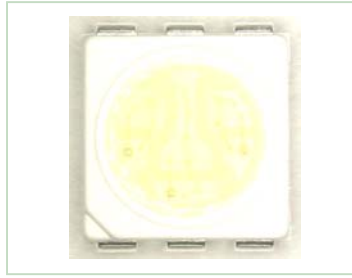

KWT728-S

Features

- White & Warm colored SMT package.
- Material : InGaN/SiC
- Encapsulating Resin : Silicone resin
- Suitable for all SMT assembly methods ; Suitable for all soldering methods
- RoHS Compliant
- MSL LEVEL 2a

Applications

- Interior automotive
- Office Automation, Electrical Appliances, Industrial Equipment

2. Absolute maximum ratings

Parameter	Symbol	Value	Unit
Power Dissipation	P_d	324	mW
Forward Current	I_F	90	mA
Peak Forward Current (Per die)	I_{FM}^{*2}	100	mA
Reverse Voltage (per die)	V_R	5	V
Operating Temperature	T_{opr}	-40 ~ +85	°C
Storage Temperature	T_{stg}	-40 ~ +100	°C

*1 Care is to be taken that power dissipation does not exceed the absolute maximum rating of the product.

*2 I_{FM} was measured at $T_w \leq 1\text{msec}$ of pulse width and $D \leq 1/10$ of duty ratio.

3. Electric & Optical characteristics

Parameter	Symbol	Condition	Min	Typ	Max	Unit
Forward Voltage (per die)	V_F	$I_F = 20\text{mA}$	3.0	3.3	3.6	V
Reverse Current (per die)	I_R	$V_R = 5\text{V}$	-	-	10	μA
Luminance Intensity ^{*1} [Cool White]	I_V	$I_F = 60\text{mA}$	4.5	6.2	-	cd
Luminance Intensity ^{*1} [Warm White]	I_V	$I_F = 60\text{mA}$	3.0	5.0	-	cd
Luminance Flux [CIE X = 0.31, Y = 0.31]	Φ_V	$I_F = 60\text{mA}$	-	20	-	lm
Color Temperature	CCT	Cool	4,700		10,000	K
		Warm	2,600	-	4,700	
Optical Efficiency	η_{elc}	$I_F = 60\text{mA}$	-	101	-	lm/W
Viewing Angle ^{*2}	$2\theta_{1/2}$	$I_F = 60\text{mA}$	-	120	-	deg
Color Rendering Index	Ra	$I_F = 60\text{mA}$		70		

*1. The luminous intensity I_V was measured at the peak of the spatial pattern which may not be aligned with the mechanical axis of the LED package. Luminous Intensity Measurement allowance is $\pm 10\%$

*2. $2\theta_{1/2}$ is the off-axis where the luminous intensity is 1/2 of the peak intensity.

[Note] All measurements were made under the standardized environment of SSC.

4. Optical characteristics

Forward Current vs. Forward Voltage
(Per die)

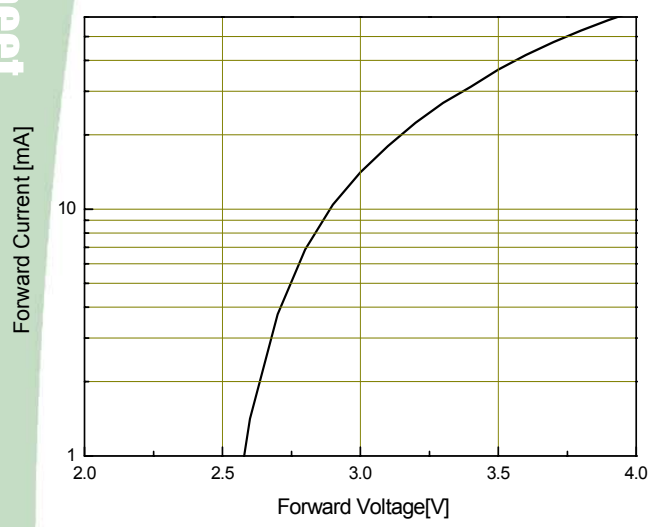

Relative Luminous Intensity
vs Forward Current

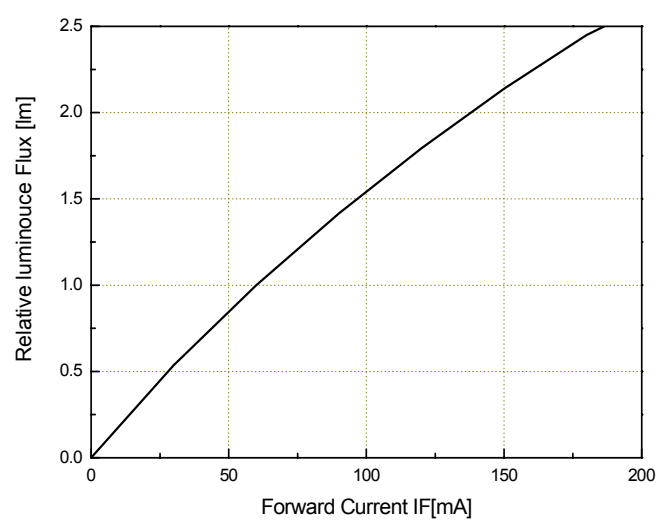

Forward Current Degrating Curve
(Per Die)

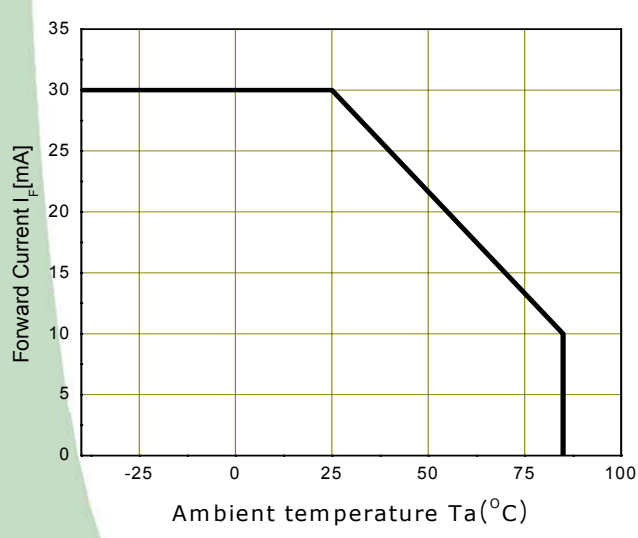

Radiation Diagram

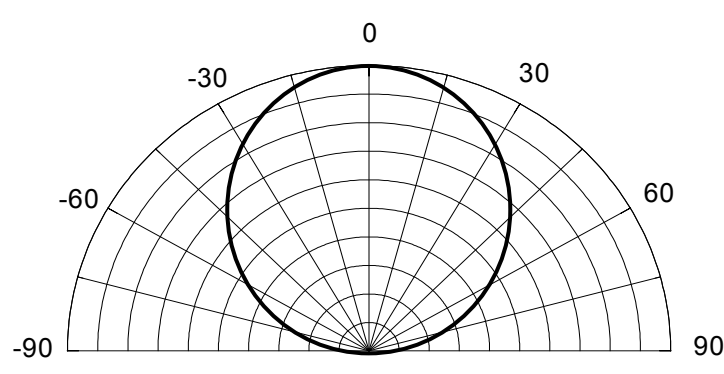

5. Reliability Test

Item	Ref.	Test Condition	Note	Number of Damage
Thermal Shock	EIAJ ED-4701	$T_a = -40^{\circ}\text{C}(30\text{MIN}) \sim 100^{\circ}\text{C}(30\text{MIN})$	1000 Cycle	0/22
High Temp. Storage	EIAJ ED-4701	$T_a = 100^{\circ}\text{C}$	1000 Hours	0/22
High Temp. High Humidity Storage	EIAJ ED-4701	$T_a = 60^{\circ}\text{C}, \text{RH}=90\%$	1000 Hours	0/22
Low Temp. Storage	EIAJ ED-4701	$T_a = -40^{\circ}\text{C}$	1000 Hours	0/22
Operating Endurance Test	Internal Reference	$T_a = 25^{\circ}\text{C}, I_F = 60\text{mA}$	1000 Hours	0/22
High Temp. High Humidity Life Test	Internal Reference	$T_a = 60^{\circ}\text{C}, \text{RH}=90\%, I_F = 60\text{mA}$	500 Hours	0/22
High Temp. life Test	Internal Reference	$T_a = 85^{\circ}\text{C}, I_F = 60\text{mA}$	1000 Hours	0/22
Low Temp. Life Test	Internal Reference	$T_a = -40^{\circ}\text{C}, I_F = 60\text{mA}$	1000 Hours	0/22
ESD(HBM)	MIL-STD-883D	1KV at 1.5k Ω ; 100pF	3 Time	0/22

□ Criteria for Judging the Damage

Item	Symbol	Condition	Criteria for Judgment	
			MIN	MAX
Forward Voltage	V_F	$I_F = 60\text{mA}$ (20mA per die)	-	USL ^{*1} × 1.2
Reverse Current	I_R	$V_R = 5\text{V}$	-	USL ^{*1} × 2.0
Luminous Intensity	I_V	$I_F = 60\text{mA}$ (20mA per die)	LSL ^{*2} × 0.5	-

Note : *1 USL : Upper Standard Level

*2 LSL : Lower Standard Level

6. Color & Binning

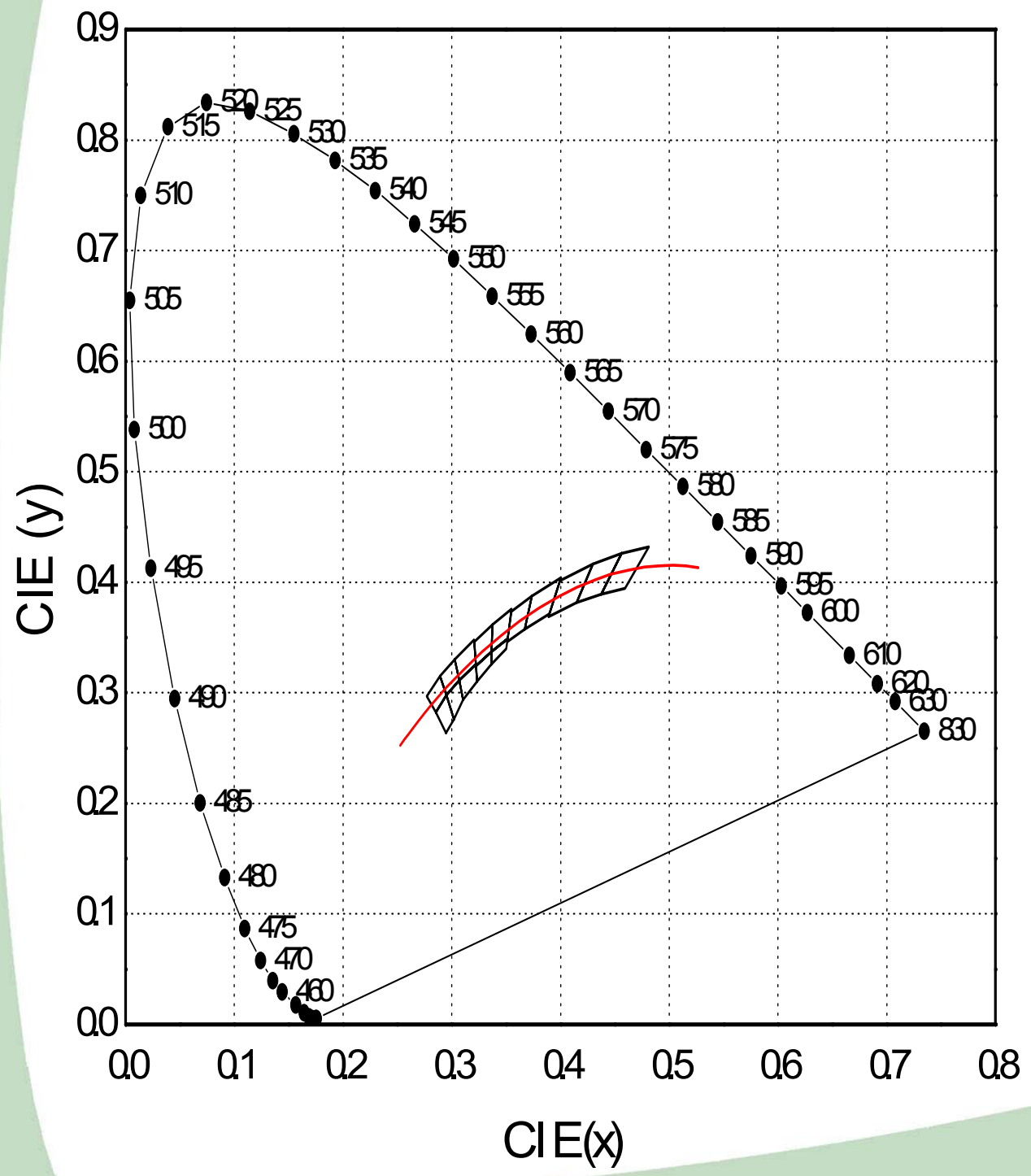

6. Color & Binning

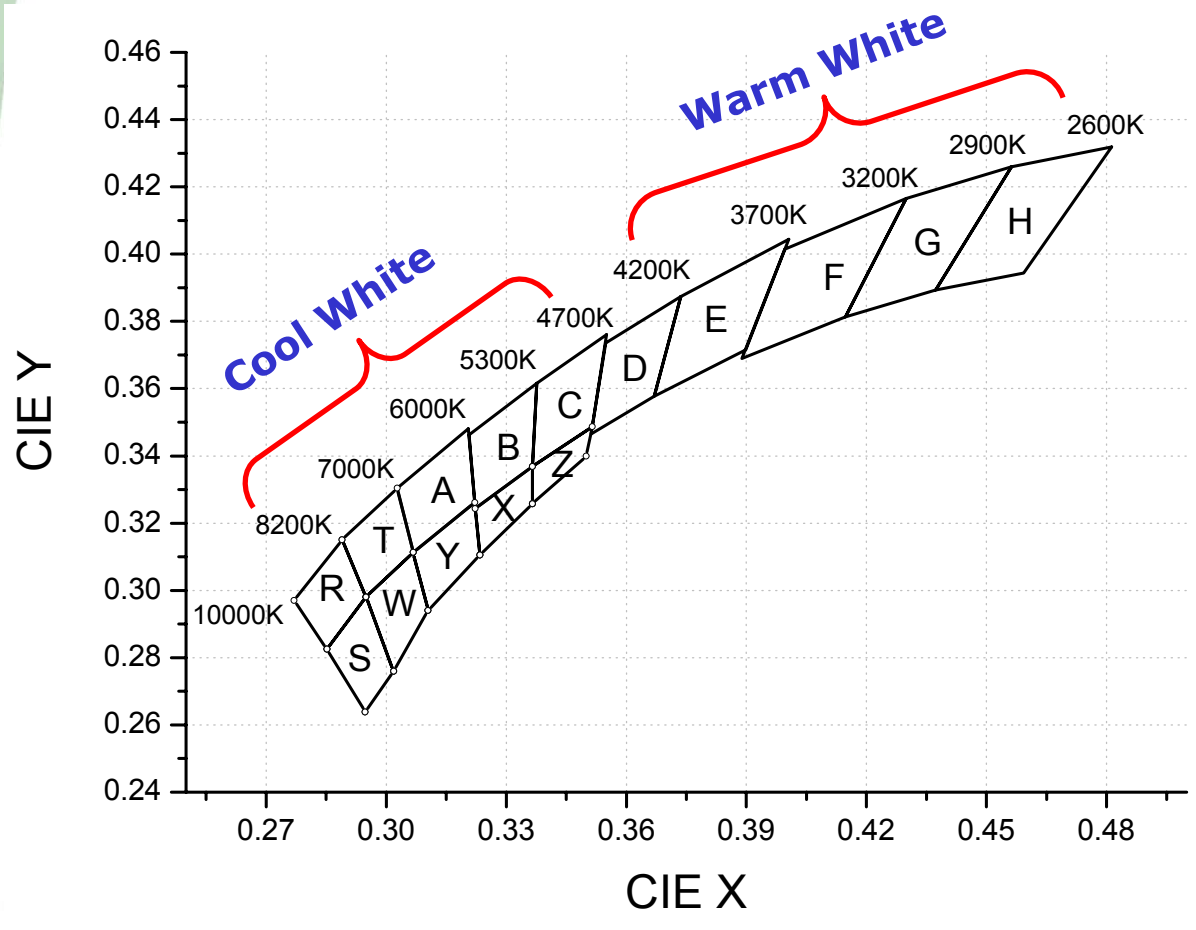

● A ~ H Bin => Energy Star CIE Standard

6. Color & Binning

● COLOR RANK

<IF=60mA, Ta=25℃>

10,000 ~ 8,200 K				8,200 ~ 7,000K			
R		T		S		W	
CIE X	CIE Y	CIE X	CIE Y	CIE X	CIE Y	CIE X	CIE Y
0.2852	0.2826	0.2947	0.2638	0.295	0.298	0.3019	0.276
0.277	0.297	0.2852	0.2826	0.289	0.315	0.295	0.298
0.289	0.315	0.295	0.298	0.3028	0.3304	0.3068	0.3113
0.295	0.298	0.3019	0.276	0.3068	0.3113	0.3104	0.294
7,000 ~ 6,000 K				6,000 ~ 5,300 K			
A		X		B		Y	
CIE X	CIE Y	CIE X	CIE Y	CIE X	CIE Y	CIE X	CIE Y
0.3028	0.3304	0.3104	0.294	0.3207	0.3462	0.3234	0.3105
0.3068	0.3113	0.3068	0.3113	0.3222	0.3243	0.3222	0.3243
0.3221	0.3261	0.3221	0.3261	0.3366	0.3369	0.3366	0.3369
0.3205	0.3481	0.3234	0.3105	0.3376	0.3616	0.3365	0.3258
5,300 ~ 4,700 K				4,700 ~ 4,200 K		4,200 ~ 3,700 K	
C		Z		D		E	
CIE X	CIE Y	CIE X	CIE Y	CIE X	CIE Y	CIE X	CIE Y
0.3376	0.3616	0.3365	0.3258	0.3548	0.3736	0.3736	0.3874
0.3366	0.3369	0.3366	0.3369	0.3512	0.3465	0.367	0.3578
0.3515	0.3487	0.3515	0.3487	0.367	0.3578	0.3898	0.3716
0.3551	0.376	0.35	0.34	0.3736	0.3874	0.4006	0.4044
3,700 ~ 3,200 K		3,200 ~ 2,900 K		2,900 ~ 2,600 K			
F		G		H			
CIE X	CIE Y	CIE X	CIE Y	CIE X	CIE Y		
0.3996	0.4015	0.4299	0.4165	0.4562	0.426		
0.3889	0.369	0.4147	0.3814	0.4373	0.3893		
0.4147	0.3814	0.4373	0.3893	0.4593	0.3944		
0.4299	0.4165	0.4562	0.426	0.4813	0.4319		

- A ~ H Bin => Energy Star CIE Standard
- 2,600~4,700 K -> Warm White
- 4,700~10,000 K -> Cool White

* Measurement Uncertainty of the Color Coordinates : ± 0.01

7. Bin Code Description

Bin Code		
Luminous Intensity	CIE	Forward Voltage
N5	A	Z3

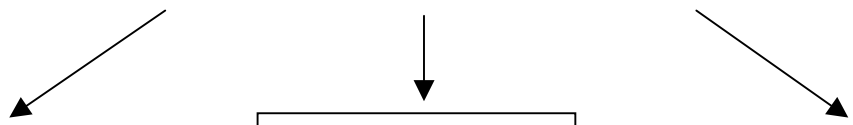

4,700K ~ 10,000K

Luminous Intensity (mcd) @ $I_F = 60\text{mA}$		
Bin Code	Min.	Max.
M5	4500	5000
N0	5000	5500
N5	5500	6000
P0	6000	6500
P5	6500	7000
Q0	7000	8000

Color Rank @ $I_F = 60\text{mA}$	
A	B
C	R
S	T
W	X
Y	Z

Forward Voltage (V) @ $I_F = 60\text{mA}$		
Bin Code	Min.	Max.
Z1	3.0	3.1
Z2	3.1	3.2
Z3	3.2	3.3
A1	3.3	3.45
A2	3.45	3.6

2,600K ~ 4,700K

Luminous Intensity (mcd) @ $I_F = 60\text{mA}$		
Bin Code	Min.	Max.
L0	3000	3500
L5	3500	4000
M0	4000	4500
M5	4500	5000
N0	5000	5500
N5	5500	6000

Color Rank @ $I_F = 60\text{mA}$	
D	
E	
F	
G	
H	

Forward Voltage (V) @ $I_F = 60\text{mA}$		
Bin Code	Min.	Max.
Z1	3.0	3.1
Z2	3.1	3.2
Z3	3.2	3.3
A1	3.3	3.45
A2	3.45	3.6

Available ranks

8. Outline Dimension

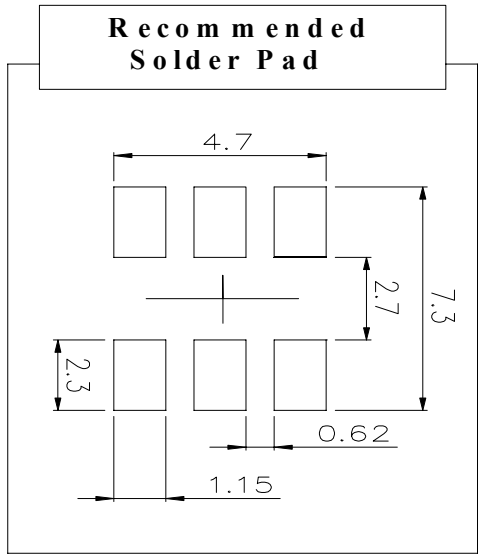
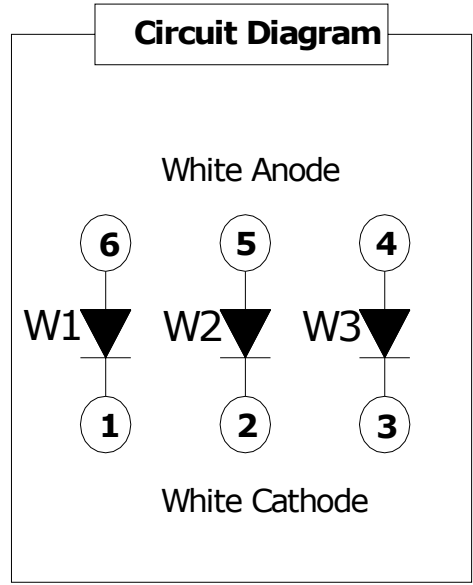
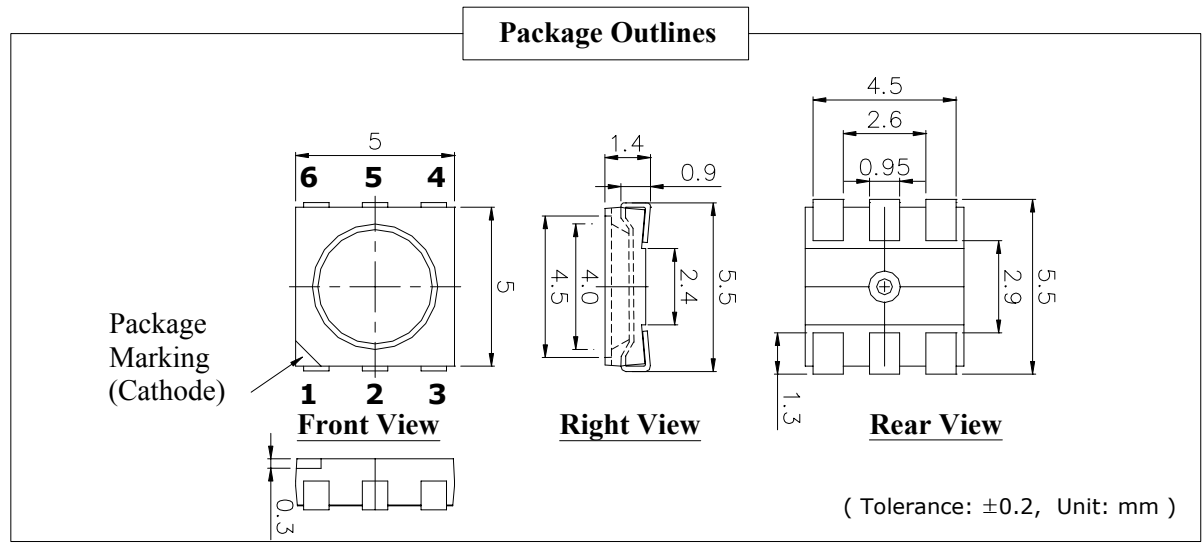

*** MATERIALS**

PARTS	MATERIALS
Package	Heat-Resistant Polymer
Encapsulating Resin	Silicone Resin
Electrodes	Ag Plating Copper Alloy

9. Packing

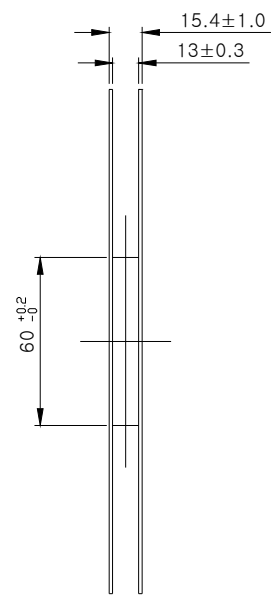
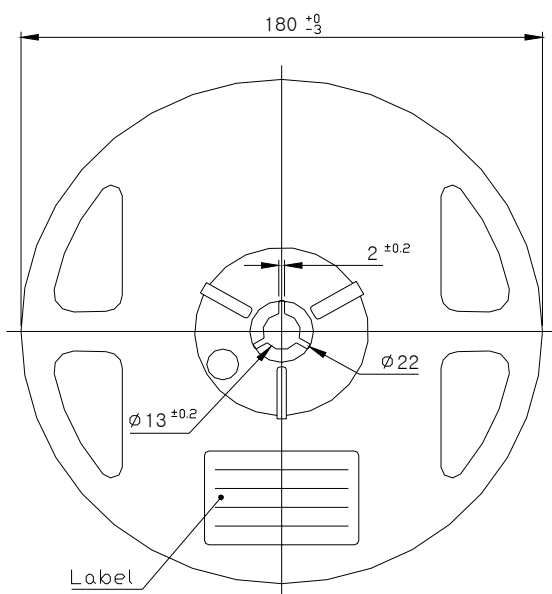
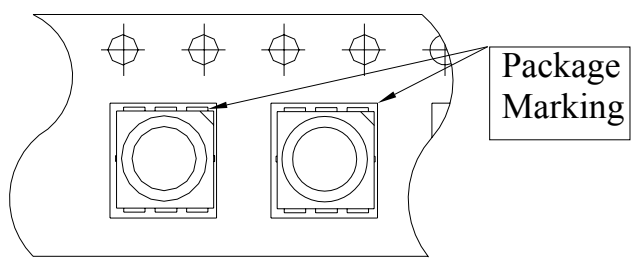
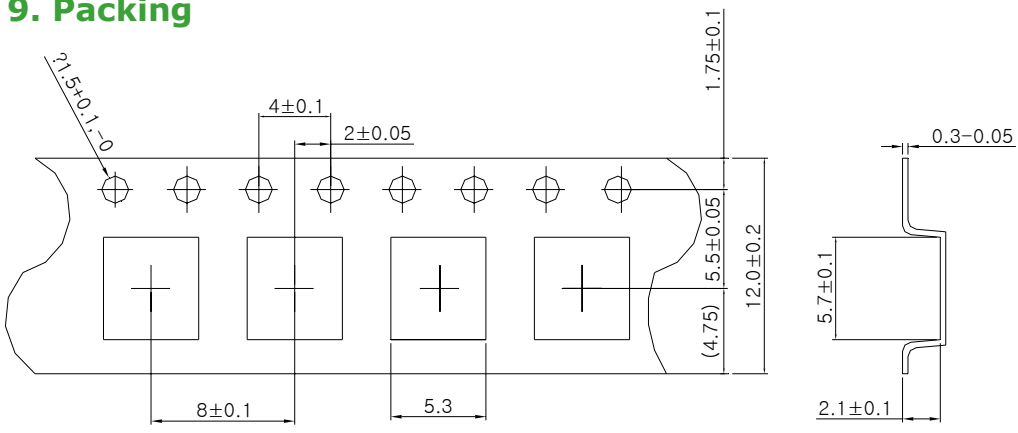

(Tolerance: ±0.2, Unit: mm)

- 1)Quantity : 1,000pcs/Reel
- 2)Cumulative Tolerance : Cumulative Tolerance/10 pitches to be ±0.2mm
- 3)Adhesion Strength of Cover Tape : Adhesion strength to be 0.1-0.7N when the cover tape is turned off from the carrier tape at the angle of 10 to the carrier tape
- 4)Package : P/N, Manufacturing data Code No. and quantity to be indicated on a damp proof Package

● Reel Packing Structure

Reel

RANK: XXXX
 QUANTITY: XXXX
 LOT NUMBER: XXXXXXXXXXXX
 PART NUMBER: XXXXXXXX
 SEOUL SEMICONDUCTOR CO., LTD.

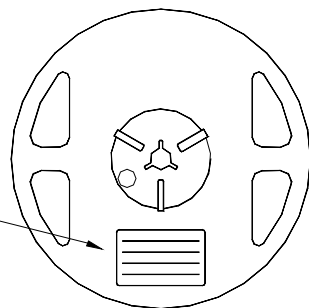

Aluminum Vinyl Bag

RANK: XXXX
 QUANTITY: XXXX
 LOT NUMBER: XXXXXXXXXXXX
 PART NUMBER: XXXXXXXX
 SEOUL SEMICONDUCTOR CO., LTD.

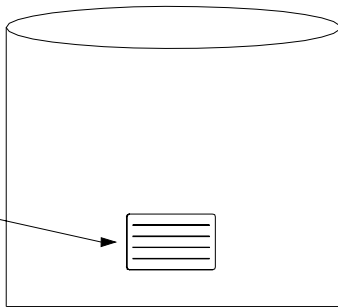

Outer Box Structure

Material : Paper(SW3B(B))

TYPE	SIZE (mm)		
	Ⓐ	Ⓑ	Ⓒ
7inch	245	220	102
	245	220	142

① SIDE

RANK: XXXX
 QUANTITY: XXXX
 LOT NUMBER: XXXXXXXXXXXX
 PART NUMBER: XXXXXXXX
 SEOUL SEMICONDUCTOR CO., LTD.

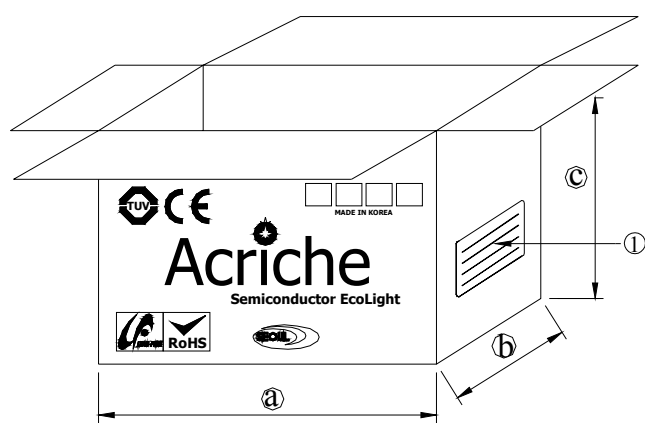

10. Soldering

(1) Lead Solder

Lead Solder	
Pre-heat	120~150℃
Pre-heat time	120 sec. Max.
Peak-Temperature	240℃ Max.
Soldering time Condition	10 sec. Max.

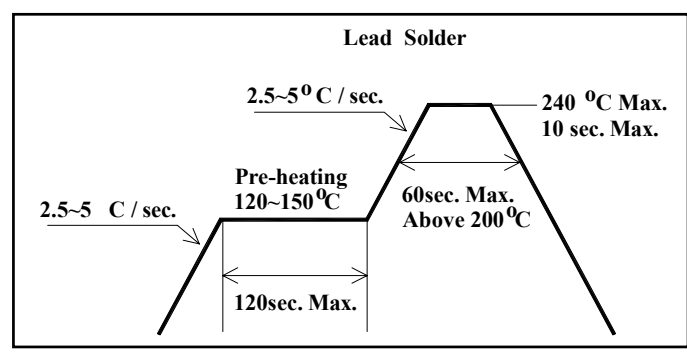

(2) Lead-Free Solder

Lead Free Solder	
Pre-heat	150~200℃
Pre-heat time	120 sec. Max.
Peak-Temperature	260℃ Max.
Soldering time Condition	10 sec. Max.

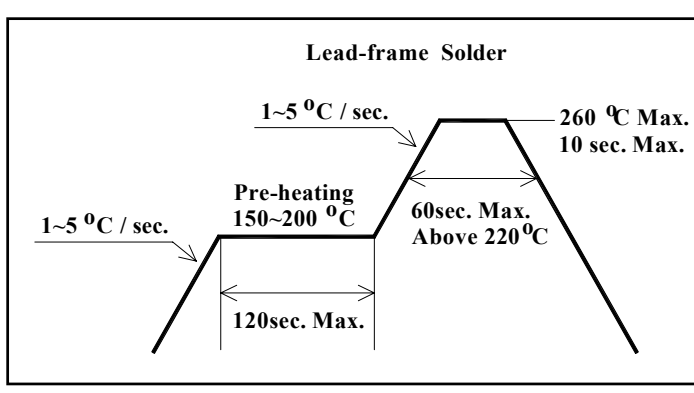

(3) Hand Soldering conditions

Do not exceed 4 seconds at maximum 315°C under soldering iron.

(4) The encapsulated material of the LEDs is silicone.

Precautions should be taken to avoid the strong pressure on the encapsulated part.

So when using the chip mounter, the picking up nozzle that does not affect the silicone resin should be used.

Note : In case that the soldered products are reused in soldering process, we don't guarantee the products.

11. Precaution for use

(1) Storage

In order to avoid the absorption of moisture, it is recommended to store in a dry box (or a desiccator) with a desiccant. Otherwise, to store them in the following environment is recommended.

Temperature : 5°C ~30°C Humidity : maximum 65%RH

(2) Attention after open.

LED is correspond to SMD, when LED be soldered dip, interfacial separation may affect the light transmission efficiency, causing the light intensity to drop. Attention in followed;

a. After opened and mounted the soldering shall be quickly.

b. Keeping of a fraction

Temperature : 5 ~ 40°C Humidity : less than 30%

(3) In the case of more than 4 week passed after opening or change color of indicator on desiccant, components shall be dried 10-12hr. at 60±5°C.

(4) Any mechanical force or any excess vibration shall not be accepted to apply during cooling process to normal temperature after soldering.

(5) Quick cooling shall be avoided.

(6) Components shall not be mounted on warped direction of PCB.

(7) Anti radioactive ray design is not considered for the products.

(8) This device should not be used in any type of fluid such as water, oil, organic solvent etc. When washing is required, IPA should be used.

(9) When the LEDs are illuminating, operating current should be decided after considering the ambient maximum temperature.

(10) LEDs must be stored to maintain a clean atmosphere. If the LEDs are stored for 3 months or more after being shipped from SSC, a sealed container with a nitrogen atmosphere should be used for storage.

(11) The LEDs must be soldered within seven days after opening the moisture-proof packing.

(12) Repack unused products with anti-moisture packing, fold to close any opening and then store in a dry place.

(13) The appearance and specifications of the product may be modified for improvement without notice.

12. Handling of Silicone Resin LEDs

(1) During processing, mechanical stress on the surface should be minimized as much as possible. Sharp objects of all types should not be used to pierce the sealing compound.



(2) In general, LEDs should only be handled from the side. By the way, this also applies to LEDs without a silicone sealant, since the surface can also become scratched.

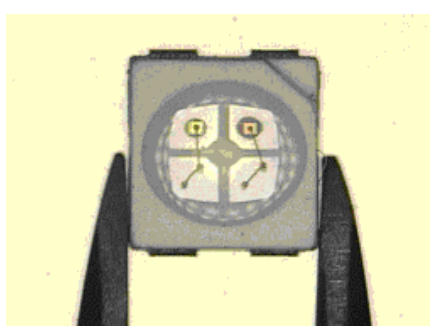

(3) When populating boards in SMT production, there are basically no restrictions regarding the form of the pick and place nozzle, except that mechanical pressure on the surface of the resin must be prevented.

This is assured by choosing a pick and place nozzle which is larger than the LED's reflector area.

(4) Silicone differs from materials conventionally used for the manufacturing of LEDs. These conditions must be considered during the handling of such devices. Compared to standard encapsulants, silicone is generally softer, and the surface is more likely to attract dust.

As mentioned previously, the increased sensitivity to dust requires special care during processing. In cases where a minimal level of dirt and dust particles cannot be guaranteed, a suitable cleaning solution must be applied to the surface after the soldering of components.

(5) SSC suggests using isopropyl alcohol for cleaning. In case other solvents are used, it must be assured that these solvents do not dissolve the package or resin.

Ultrasonic cleaning is not recommended. Ultrasonic cleaning may cause damage to the LED.