



Specification KWT803-S

| SSC | | CUSTOMER |
|-------|----------|----------|
| Drawn | Approval | Approval |
| | | |

Contents

1. Description
2. Absolute Maximum Ratings
3. Electro-Optical Characteristics
4. Characteristic Graph
5. Reliability Test Item and Condition
6. Color & Binning
7. Outline Dimension
8. Packing
9. Soldering
10. Precaution for use
11. Handling of Silicone Resin LEDs

KWT803-S

1. Description

This surface-mount LED comes in PLCC standard package dimension. It has a substrate made up of a molded plastic reflector sitting on top of a bent lead frame. The die is attached within the reflector cavity and the cavity is encapsulated by epoxy or silicone.

The package design coupled with careful selection of component materials allow these products to perform with high reliability in a larger temperature range -40°C to 100°C . The high reliability feature is crucial to Automotive interior and Indoor ESS.



Features

- White colored SMT package
- InGaN/Sic material
- Suitable for all SMT assembly and soldering methods
- Pb-Free Reflow soldering application
- RoHS compliant

Applications

- White Back-light
- Electric Signs and Signals
- Interior automotive
- Office Automation, Electrical Appliances, Industrial Equipment

2. Absolute maximum ratings*1

| Parameter | Symbol | Value | Unit |
|-----------------------|-------------|------------|------|
| Power Dissipation | P_d | 111 | mW |
| Forward Current | I_F | 30 | mA |
| Peak Forward Current | I_{FM} *2 | 90 | mA |
| Reverse Voltage | V_R | 5 | V |
| Operating Temperature | T_{opr} | -40 ~ +100 | °C |
| Storage Temperature | T_{stg} | -40 ~ +100 | °C |

*1 Care is to be taken that power dissipation does not exceed the absolute maximum rating of the product.

*2 I_{FM} was measured at $T_w \leq 1$ msec of pulse width and $D \leq 1/10$ of duty ratio.

3. Electro-Optical characteristics

| Parameter | Symbol | Condition | Min | Typ | Max | Unit |
|----------------------|-----------------|------------------|------|------|------|------|
| Forward Voltage | V_F | $I_F=20$ mA | 2.7 | 3.3 | 3.7 | V |
| Reverse Current | I_R | $V_R=5$ V | - | - | 10 | μA |
| Luminous Intensity*1 | I_V | $I_F=20$ mA | 1200 | 1600 | 2400 | mcd |
| Viewing Angle *2 | $2\theta_{1/2}$ | $I_F=20$ mA | - | 115 | - | deg. |
| ESD (HBM) | | 1.5kΩ ; 100pF | 1 | - | - | KV |

*1. The luminous intensity I_V was measured at the peak of the spatial pattern which may not be aligned with the mechanical axis of the LED package. Luminous Intensity Measurement allowance is $\pm 10\%$

*2. $2\theta_{1/2}$ is the off-axis where the luminous intensity is 1/2 of the peak intensity.

[Note] All measurements were made under the standardized environment of SSC.

4. Characteristic Graph

Forward Current vs. Forward Voltage

($T_a=25\text{ }^\circ\text{C}$)

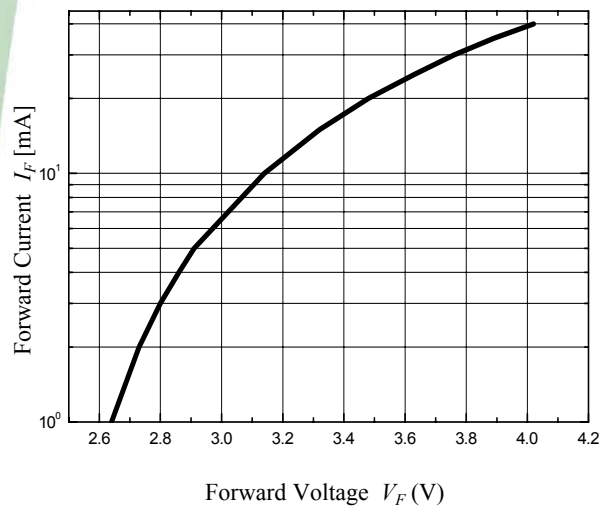

Relative Luminous Intensity vs Forward Current

($T_a=25\text{ }^\circ\text{C}$)

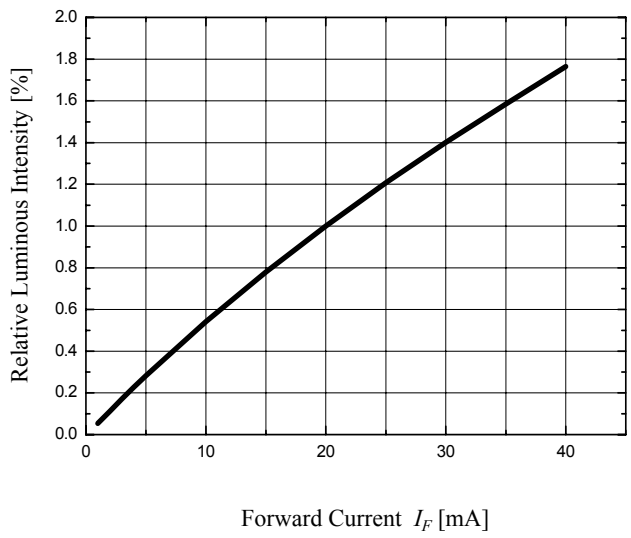

Forward Current Derating Curve

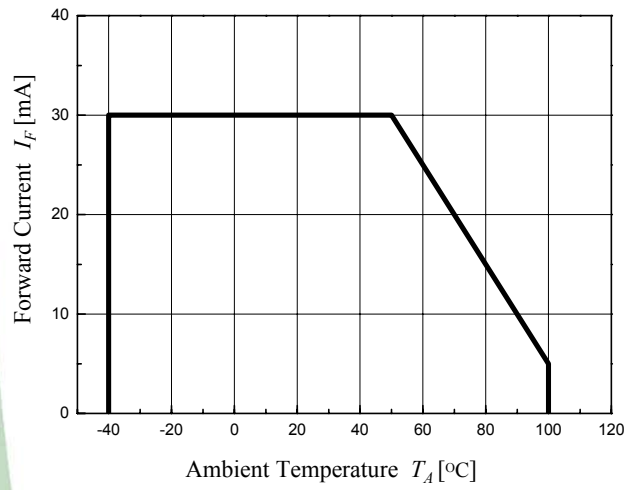

Radiation Diagram

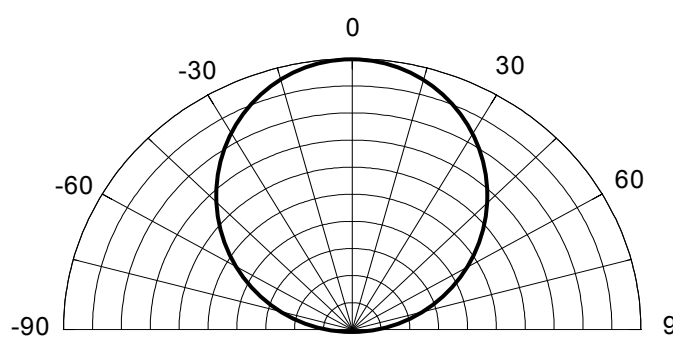

5 Reliability

| Item | Reference | Test Condition | Duration / Cycle | Number of Damage |
|--|--------------------|--|------------------|------------------|
| Thermal Shock | Internal Reference | $T_a = -40^{\circ}\text{C}$ (30MIN) ~ 100°C (30MIN) | 100 Cycle | 0/22 |
| Temperature Cycle | EIAJ ED-4701 | $T_a = -40^{\circ}\text{C}$ (30MIN) ~ 25°C (5MIN) ~ 100°C (30MIN) ~ 25°C (5MIN) | 100 Cycle | 0/22 |
| High Temperature Storage | EIAJ ED-4701 | $T_a = 100^{\circ}\text{C}$ | 1000 Hours | 0/22 |
| High Temperature High Humidity Storage | EIAJ ED-4701 | $T_a = 85^{\circ}\text{C}$, RH=85% | 1000 Hours | 0/22 |
| Low Temperature Storage | EIAJ ED-4701 | $T_a = -40^{\circ}\text{C}$ | 1000 Hours | 0/22 |
| Operating Endurance Test | Internal Reference | $T_a = 25^{\circ}\text{C}$, $I_F = 30\text{mA}$ | 1000 Hours | 0/22 |
| High Temperature High Humidity Life Test | Internal Reference | $T_a = 85^{\circ}\text{C}$, RH=85%, $I_F = 15\text{mA}$ | 1000 Hours | 0/22 |
| High Temperature Life Test | Internal Reference | $T_a = 100^{\circ}\text{C}$, $I_F = 5\text{mA}$ | 1000 Hours | 0/22 |
| Low Temperature Life Test | Internal Reference | $T_a = -40^{\circ}\text{C}$, $I_F = 30\text{mA}$ | 1000 Hours | 0/22 |
| ESD(HBM) | MIL-STD-883D | 1KV at 1.5k Ω ; 100pF | 3 Time | 0/22 |

□ Criteria for Judging the Damage

| Item | Symbol | Condition | Criteria for Judgement | |
|--------------------|--------|---------------------|------------------------|--------------------|
| | | | MIN | MAX |
| Forward Voltage | V_F | $I_F = 20\text{mA}$ | - | USL*1 \times 1.2 |
| Reverse Current | I_R | $V_R = 5\text{V}$ | - | USL*1 \times 2.0 |
| Luminous Intensity | I_V | $I_F = 20\text{mA}$ | LSL*2 \times 0.5 | - |

Note : *1 USL : Upper Standard Level
*2 LSL : Lower Standard Level

6. Color & Binning

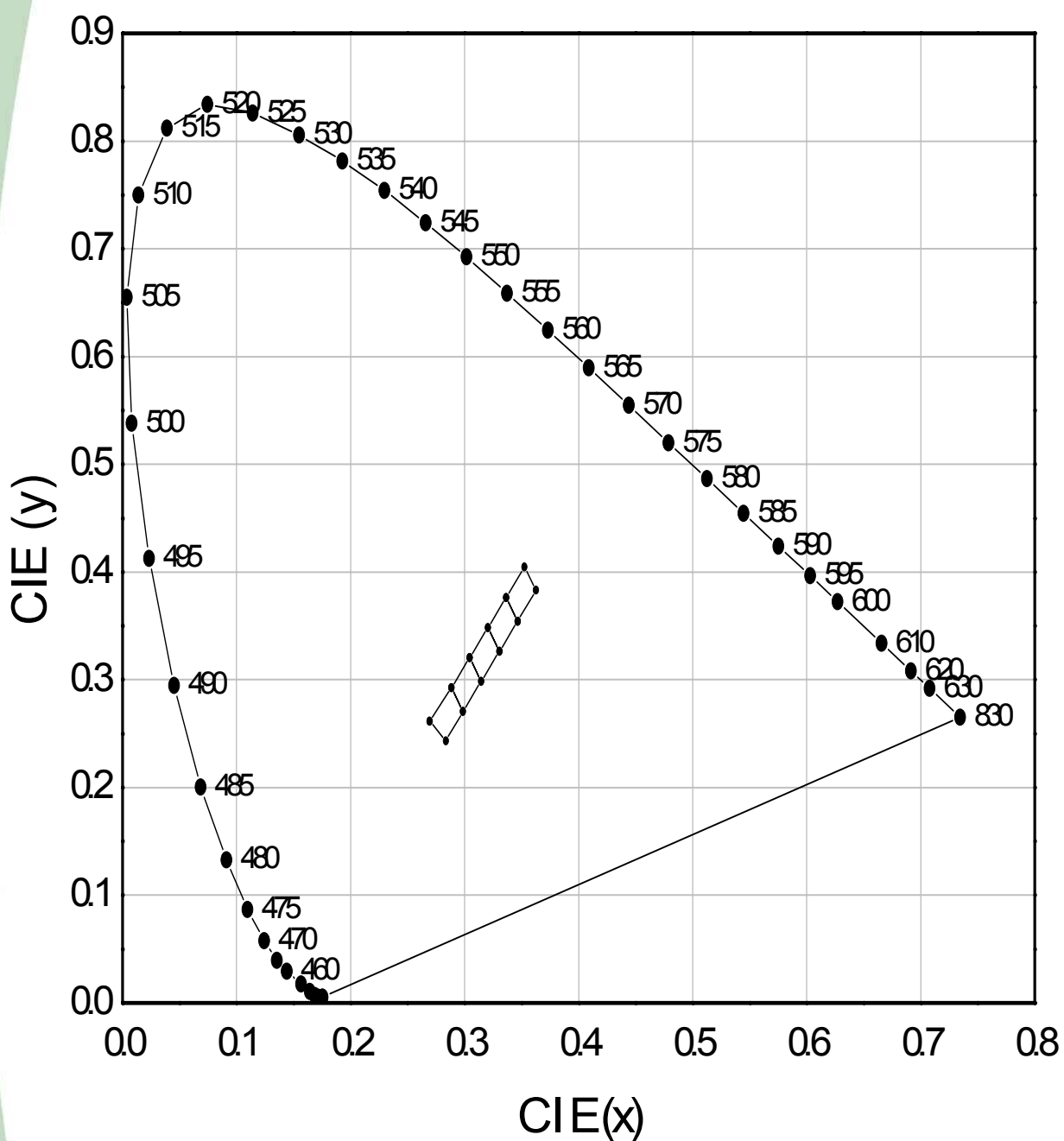

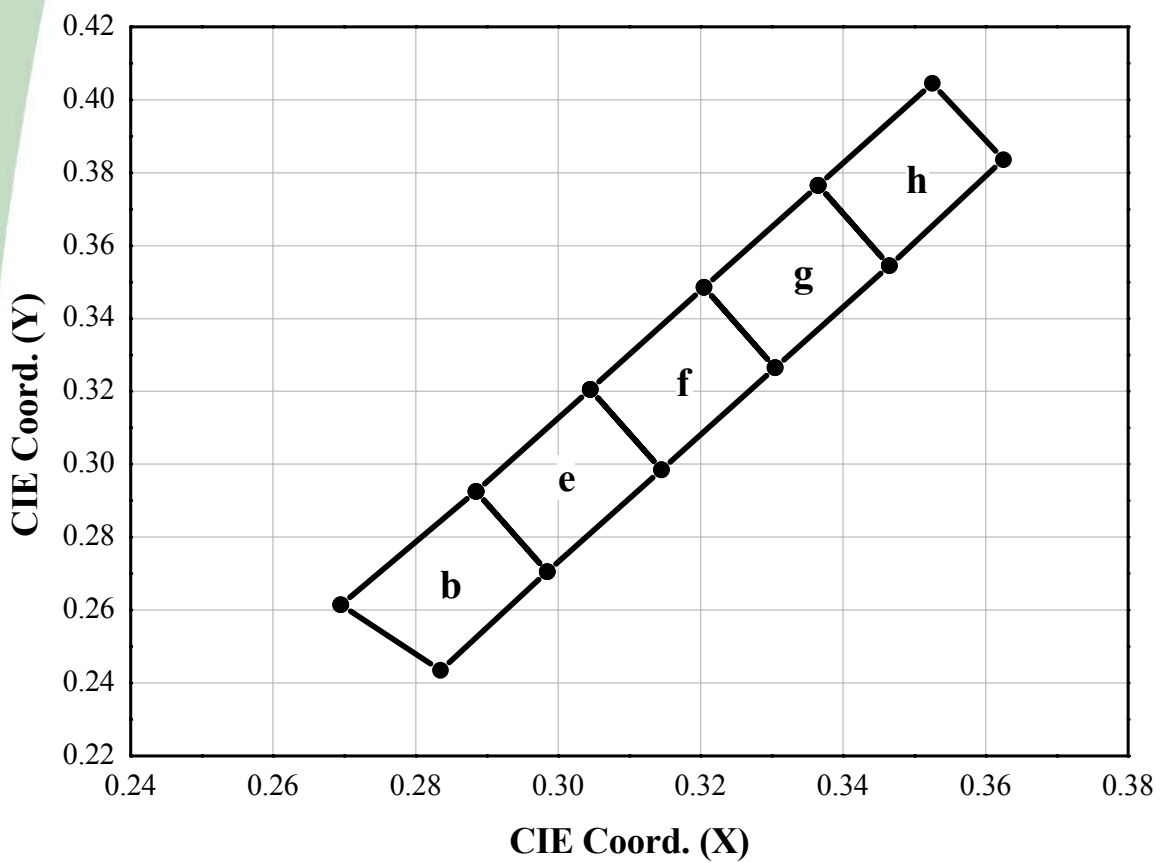

● COLOR RANK

<IF=20mA, Ta=25°C>

| b | | e | | f | |
|--------|--------|--------|--------|--------|--------|
| x | y | x | y | x | y |
| 0.2695 | 0.2615 | 0.2885 | 0.2925 | 0.3045 | 0.3205 |
| 0.2835 | 0.2435 | 0.2985 | 0.2705 | 0.3145 | 0.2985 |
| 0.2985 | 0.2705 | 0.3145 | 0.2985 | 0.3305 | 0.3265 |
| 0.2885 | 0.2925 | 0.3045 | 0.3205 | 0.3205 | 0.3485 |
| g | | h | | | |
| x | y | x | y | | |
| 0.3205 | 0.3485 | 0.3365 | 0.3765 | | |
| 0.3305 | 0.3265 | 0.3465 | 0.3545 | | |
| 0.3465 | 0.3545 | 0.3625 | 0.3835 | | |
| 0.3365 | 0.3765 | 0.3525 | 0.4045 | | |

* Measurement Uncertainty of the Color Coordinates : ± 0.01

Bin Code Description

| Bin Code | | |
|--------------------|-----|-----------------|
| Luminous Intensity | CIE | Forward Voltage |
| J8 | f | Z |

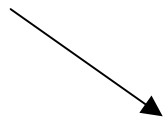
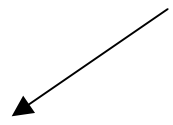

| Luminous Intensity (mcd) @ $I_F = 20\text{mA}$ | | |
|---|-------|-------|
| Bin Code | Min. | Max. |
| J2 | 1,200 | 1,400 |
| J4 | 1,400 | 1,600 |
| J6 | 1,600 | 1,800 |
| J8 | 1,800 | 2,000 |
| K0 | 2,000 | 2,200 |
| K2 | 2,200 | 2,400 |

| Color Rank @ $I_F = 20\text{mA}$ |
|-------------------------------------|
| b |
| e |
| f |
| g |
| h |

| Forward Voltage (V) @ $I_F = 20\text{mA}$ | | |
|--|------|------|
| Bin Code | Min. | Max. |
| Y | 2.7 | 3.0 |
| Z | 3.0 | 3.3 |
| A | 3.3 | 3.7 |

7. Outline Dimension

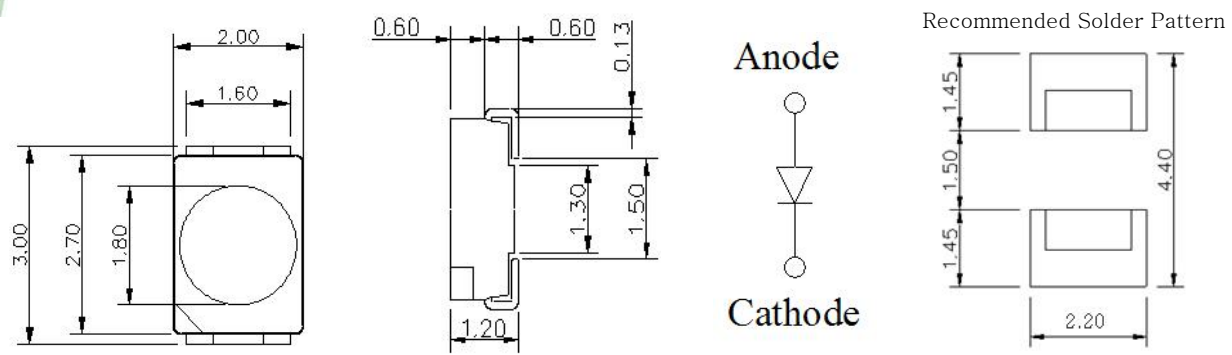

(Tolerance: ± 0.2 , Unit: mm)

8. packing

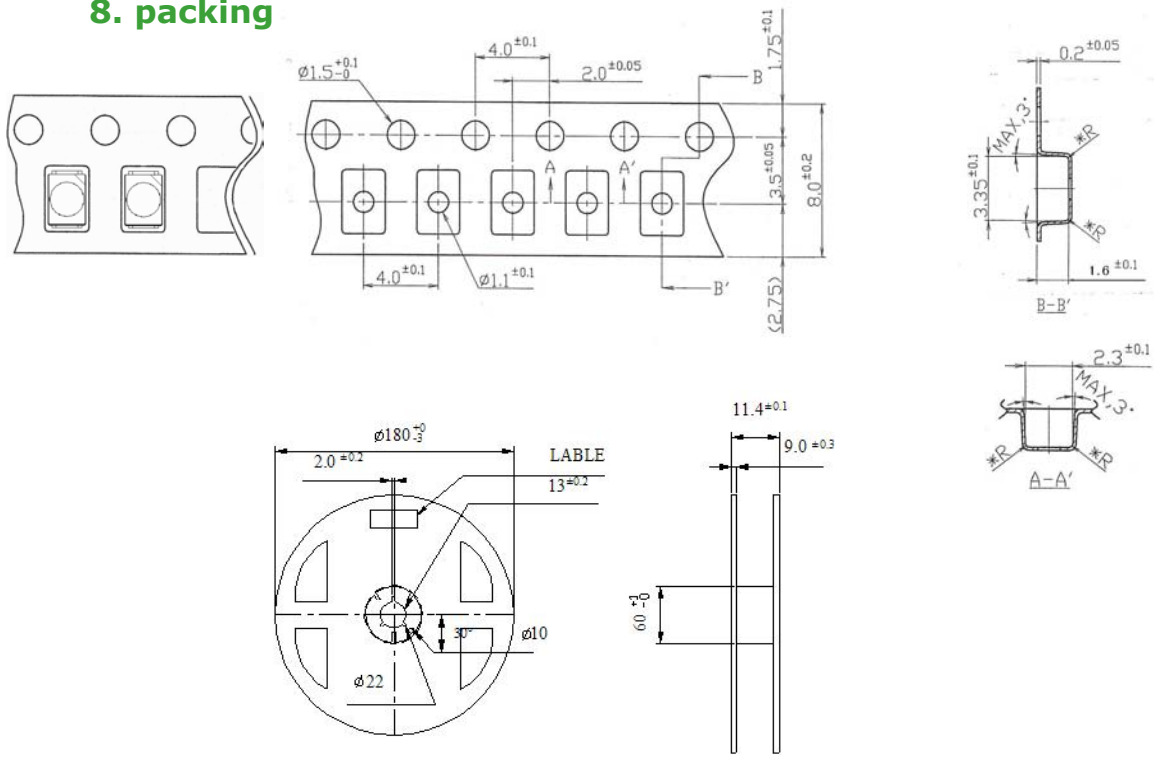

(Tolerance: ± 0.2 , Unit: mm)

- (1) Quantity : 3000pcs/Reel, 2000pcs/Reel
- (2) Cumulative Tolerance : Cumulative Tolerance/10 pitches to be ± 0.2 mm
- (3) Adhesion Strength of Cover Tape : Adhesion strength to be 0.1~0.7N when the cover tape is turned off from the carrier tape at the angle of 10° to the carrier tape
- (4) Package : P/N, Manufacturing data Code No. and quantity to be indicated on a damp proof Package

● Reel Packing Structure

Reel

RANK: XXXX
 QUANTITY: XXXX
 LOT NUMBER: XXXXXXXXXXXX
 PART NUMBER: XXXXXXXX
 SEOUL SEMICONDUCTOR CO., LTD.

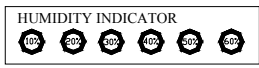
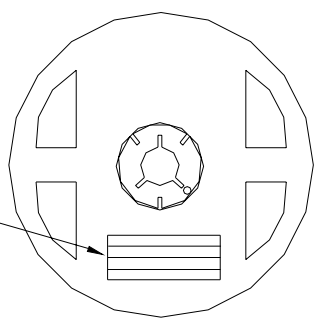

Aluminum Vinyl Bag

RANK: XXXX
 QUANTITY: XXXX
 LOT NUMBER: XXXXXXXXXXXX
 PART NUMBER: XXXXXXXX
 SEOUL SEMICONDUCTOR CO., LTD.

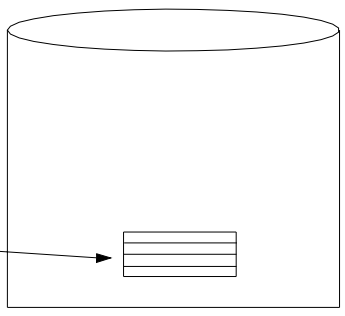

Outer Box Structure

Material : Paper(SW3B(B))

| TYPE | SIZE (mm) | | |
|-------|-----------|-----|------------|
| | Ⓐ | Ⓑ | Ⓒ |
| 7inch | 245 | 220 | 102 or 142 |

① SIDE

RANK: XXXX
 QUANTITY: XXXX
 LOT NUMBER: XXXXXXXXXXXX
 PART NUMBER: XXXXXXXX
 SEOUL SEMICONDUCTOR CO., LTD.

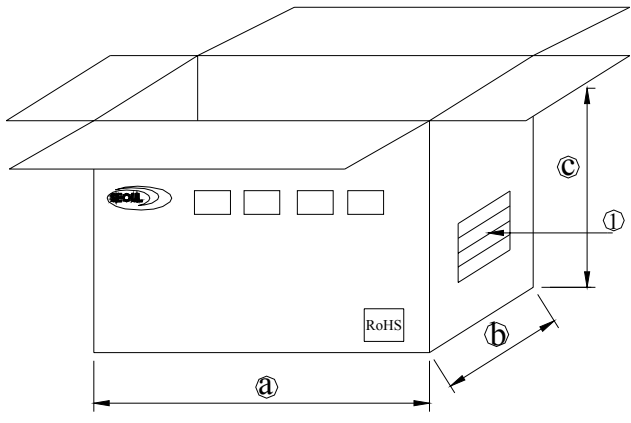

9. soldering

(1) Lead Solder

| Lead Solder | |
|--------------------------|---------------|
| Pre-heat | 120~150°C |
| Pre-heat time | 120 sec. Max. |
| Peak-Temperature | 240°C Max. |
| Soldering time Condition | 10 sec. Max. |

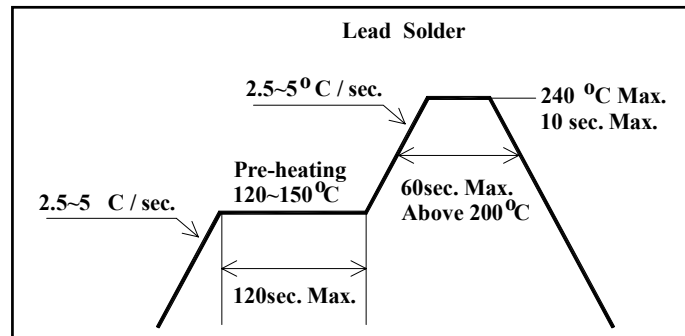

(2) Lead-Free Solder

| Lead Free Solder | |
|--------------------------|---------------|
| Pre-heat | 150~200°C |
| Pre-heat time | 120 sec. Max. |
| Peak-Temperature | 260°C Max. |
| Soldering time Condition | 10 sec. Max. |

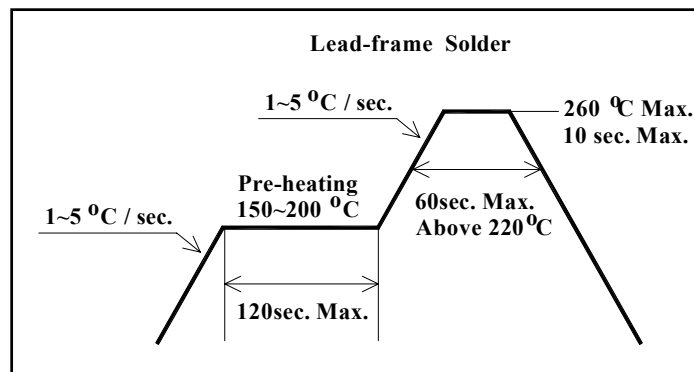

(3) Hand Soldering conditions

Do not exceed 4 seconds at maximum 315°C under soldering iron.

(4) The encapsulated material of the LEDs is silicone.

Precautions should be taken to avoid the strong pressure on the encapsulated part.

So when using the chip moulder, the picking up nozzle that does not affect the silicone resin should be used.

Note : In case that the soldered products are reused in soldering process, we don't guarantee the products.

10. precaution for use

(1) Storage

In order to avoid the absorption of moisture, it is recommended to store in a dry box (or a desiccator) with a desiccant. Otherwise, to store them in the following environment is recommended.

Temperature : 5°C ~30°C Humidity : maximum 70%RH

(2) Attention after open.

LED is correspond to SMD, when LED be soldered dip, interfacial separation may affect the light transmission efficiency, causing the light intensity to drop. Attention in followed; Keeping of a fraction

Temperature : 5 ~ 40°C Humidity : less than 10%

(3) In the case of more than 1 week passed after opening or change color of indicator on desiccant, components shall be dried 10-12hr. at 60±5°C.

(4) Any mechanical force or any excess vibration shall not be accepted to apply during cooling process to normal temperature after soldering.

(5) Quick cooling shall be avoided.

(6) Components shall not be mounted on warped direction of PCB.

(7) Anti radioactive ray design is not considered for the products.

(8) This device should not be used in any type of fluid such as water, oil, organic solvent etc. When washing is required, IPA should be used.

(9) When the LEDs are illuminating, operating current should be decided after considering the ambient maximum temperature.

(10) The LEDs must be soldered within seven days after opening the moisture-proof packing.

(11) Repack unused products with anti-moisture packing, fold to close any opening and then store in a dry place.

(12) The appearance and specifications of the product may be modified for improvement without notice.

11. Handling of Silicone Resin LEDs

(1) During processing, mechanical stress on the surface should be minimized as much as possible. Sharp objects of all types should not be used to pierce the sealing compound.



(2) In general, LEDs should only be handled from the side. By the way, this also applies to LEDs without a silicone sealant, since the surface can also become scratched.

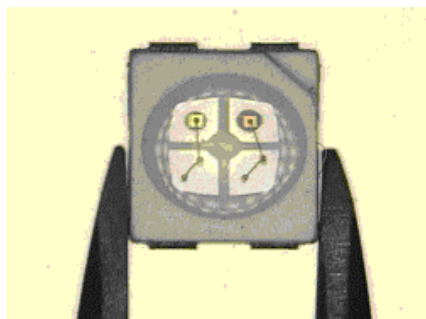

(3) When populating boards in SMT production, there are basically no restrictions regarding the form of the pick and place nozzle, except that mechanical pressure on the surface of the resin must be prevented. This is assured by choosing a pick and place nozzle which is larger than the LED's reflector area.

(4) Silicone differs from materials conventionally used for the manufacturing of LEDs. These conditions must be considered during the handling of such devices. Compared to standard encapsulants, silicone is generally softer, and the surface is more likely to attract dust.

As mentioned previously, the increased sensitivity to dust requires special care during processing. In cases where a minimal level of dirt and dust particles cannot be guaranteed, a suitable cleaning solution must be applied to the surface after the soldering of components.

(5) SSC suggests using isopropyl alcohol for cleaning. In case other solvents are used, it must be assured that these solvents do not dissolve the package or resin. Ultrasonic cleaning is not recommended. Ultrasonic cleaning may cause damage to the LED.